

Technical Dimensions

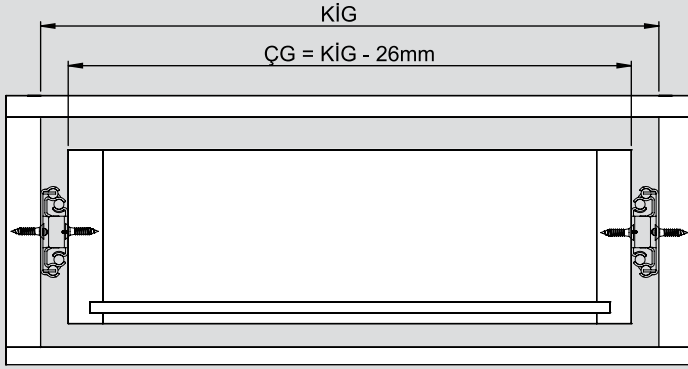

Parts

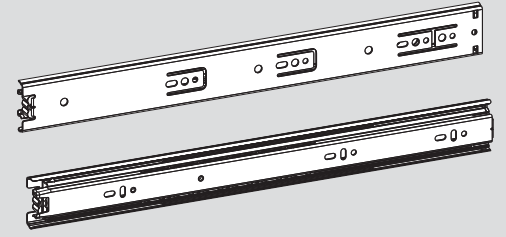

Recommended Screw



Cabinet Dimensions

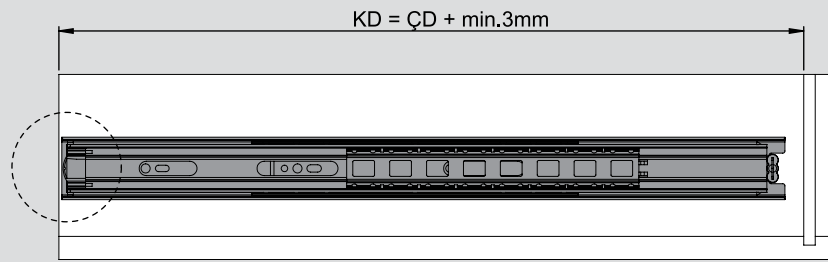
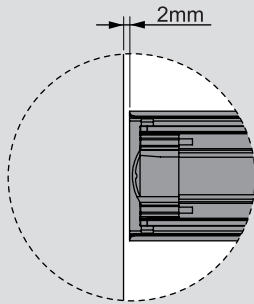

Drawer Dimensions

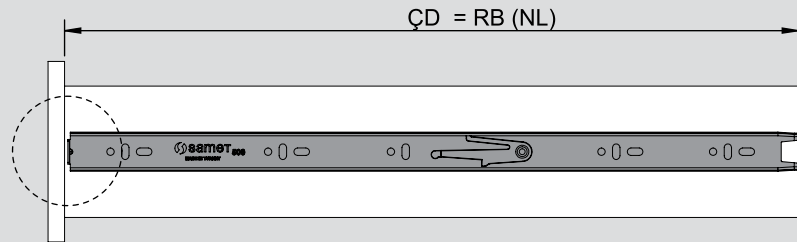
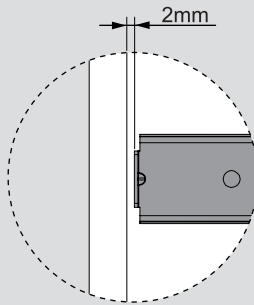

KİG : Kabin İç Genişliği / Cabinet Inner Width
ÇG : Çekmece Genişliği / Drawer Width

KD : Kabin Derinliği / Cabinet Depth
ÇD : Çekmece Derinliği / Drawer Depth

RB : Ray Uzunluğu / Nominal Length

Assembly

1

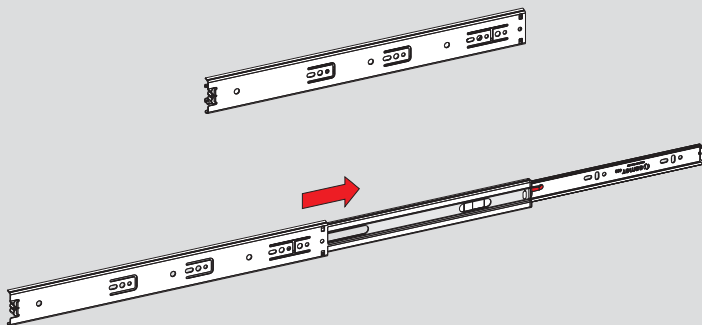

2

