

Product Selection Table

Mechanism	A1		B1		C1	
	min. Kg	max. Kg	min. Kg	max. Kg	min. Kg	max. Kg
Door Height						
200 mm	3,6	6,5	5	9,7	7	14,7
201-250 mm	3,4	5,3	4	7,5	5,5	12,2
251-300 mm	1,9	4,9	3	5,9	4,5	9,9
301-350 mm	1,6	3,6	2,8	5	4	7,9
351-400 mm	1,4	3,1	2,4	4,2	3,6	7,2
401-450 mm	1,3	2,8	2,2	3,8	3,2	6,3
451-500 mm	1,2	2,5	2	3,4	2,8	5,5
501-550 mm	1	2,2	1,75	3	2,6	5,1
551-600 mm	0,95	2	1,7	2,8	2,5	4,6

More powerful mechanism is recommended for intersection areas.

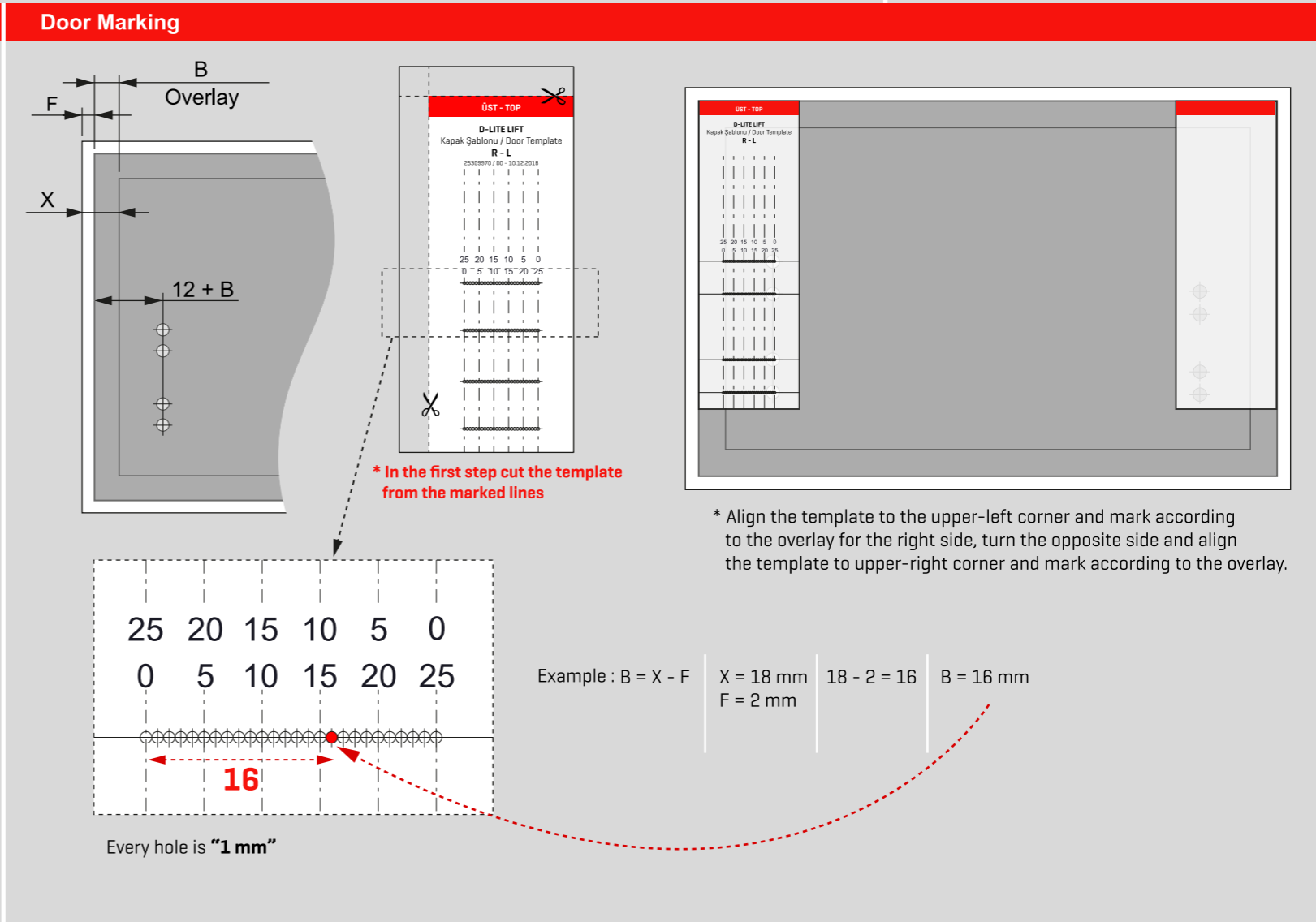

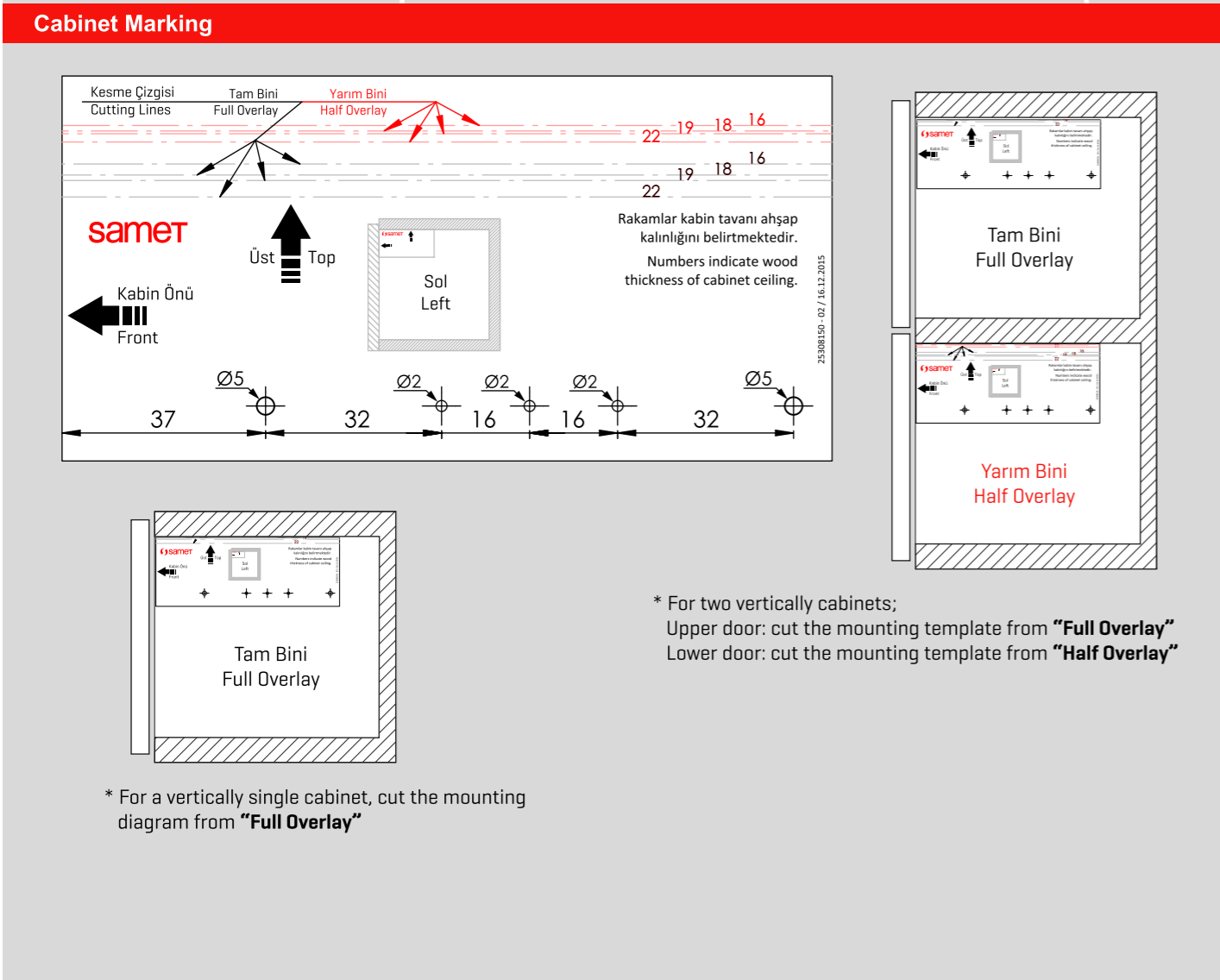
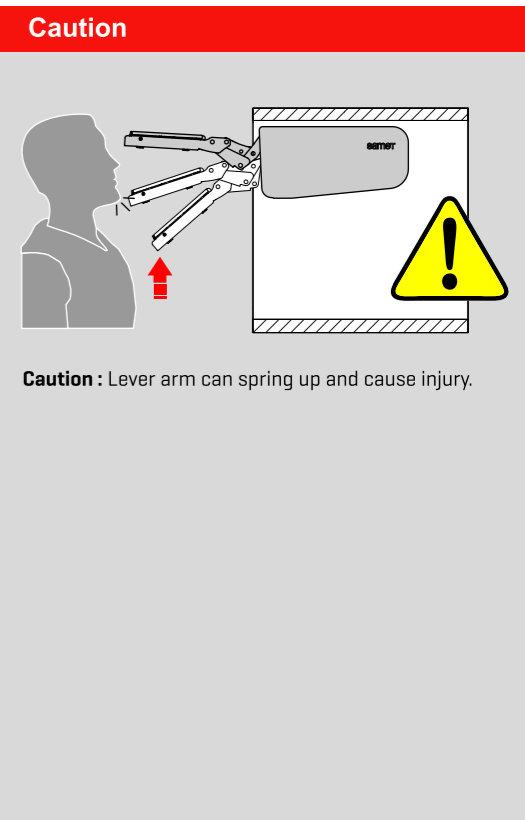
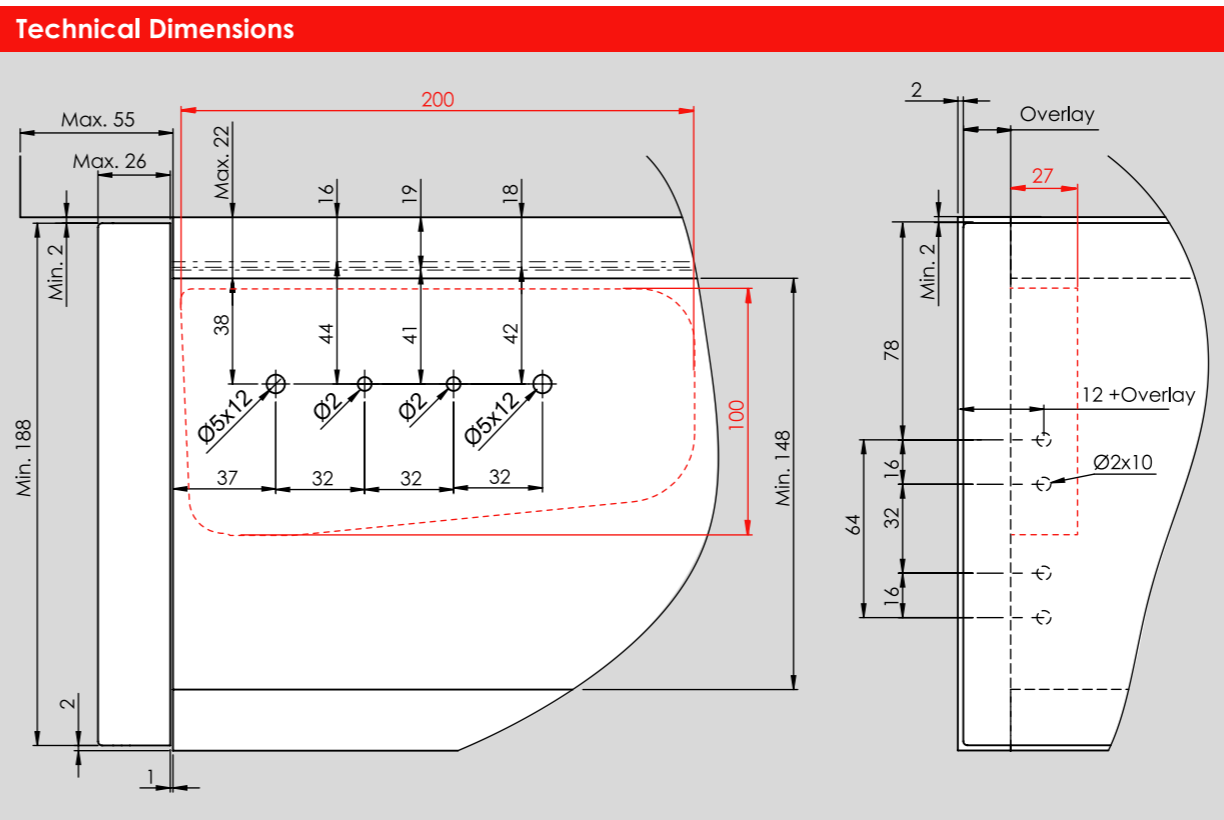

Assembly

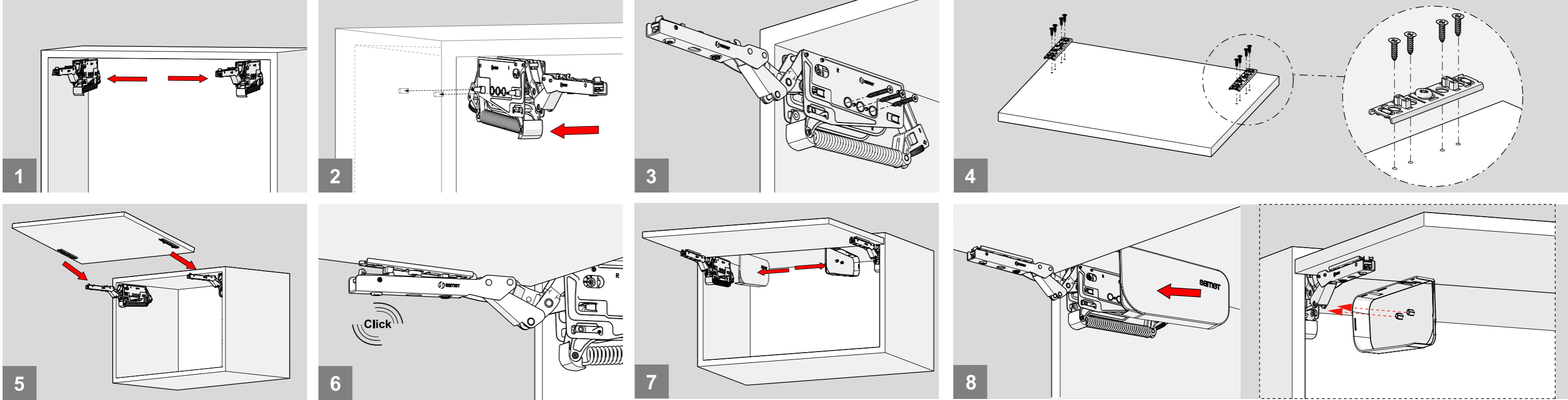

Adjustment

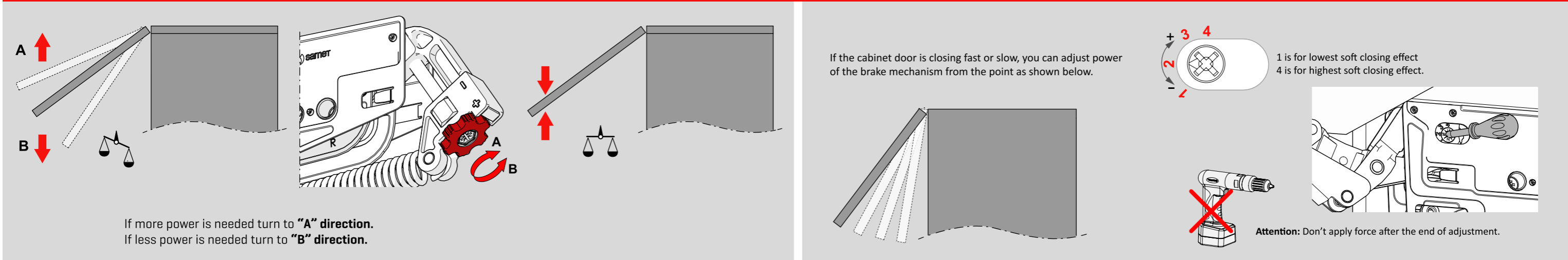

Adjustment

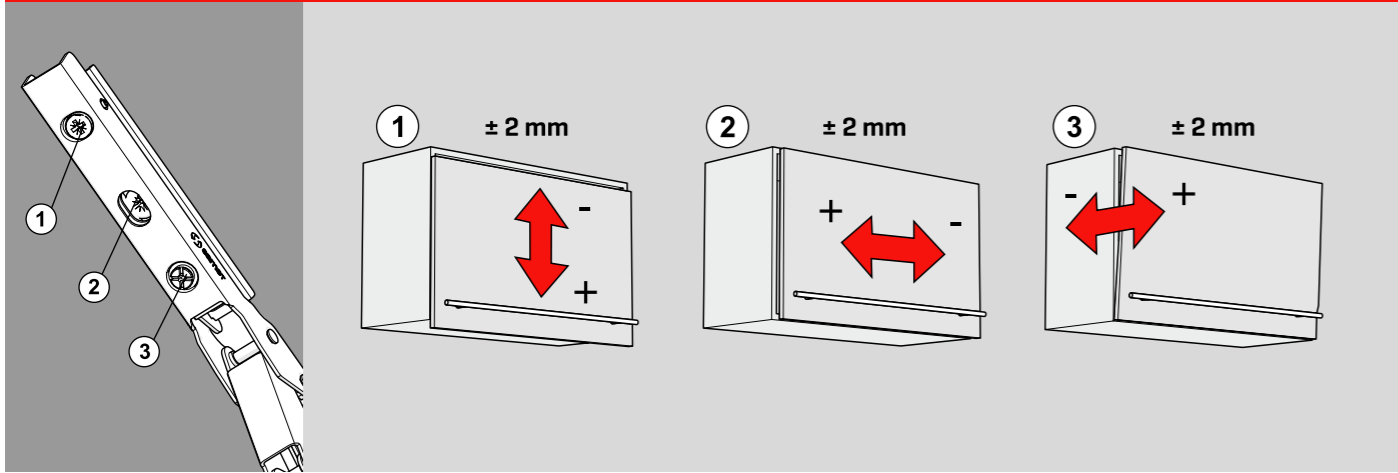

90° Opening Angle

