

Cabinet Dimensions

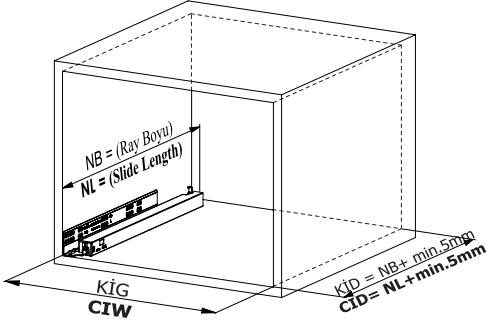

Cabinet Internal Width : CIW
Cabinet Internal Depth : CID
Drawer Depth : DD
Drawer Internal Width : DIW
Nominal Length : NL

Recommended Screw and Templates

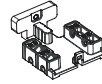
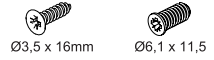

Smart Lock Template

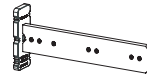

Smart Drilling Jig

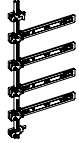

Smart Drilling Jig with Ruler

Screw Location for the Slides *Screw the slide from marked holes.*

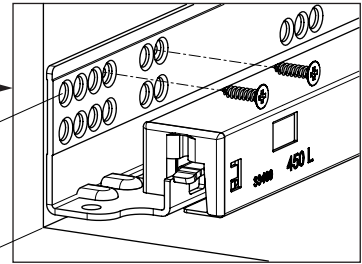
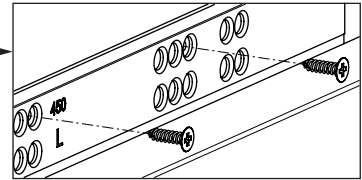
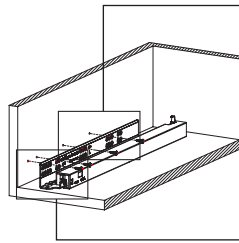
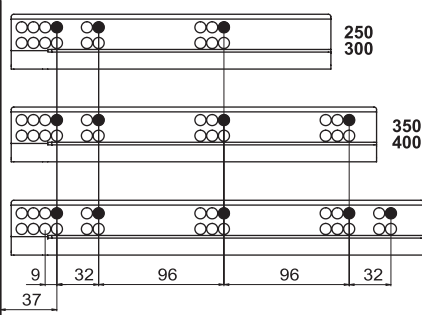

Drawer Dimensions

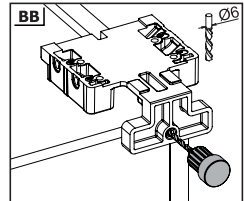
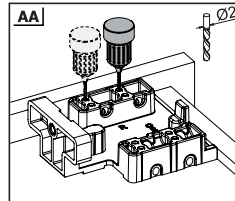
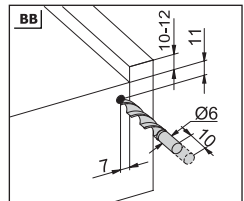
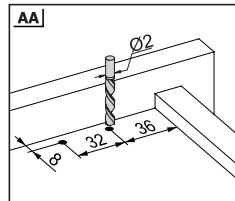
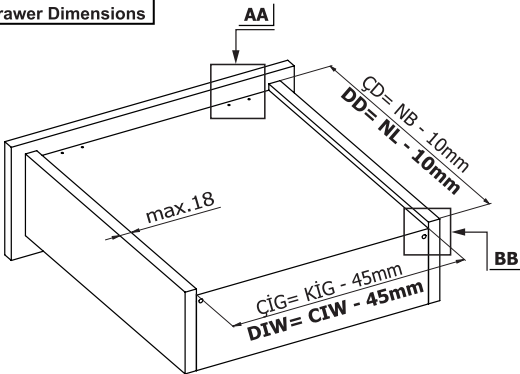

1

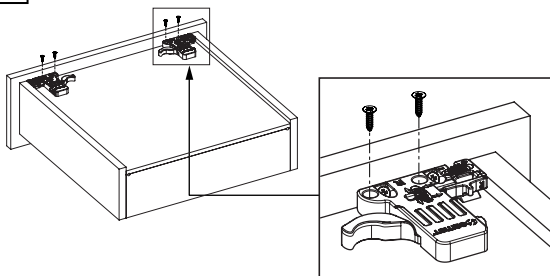

Note: Use angled holes to mount smart lock when wooden floor width is selected less than 12 mm.

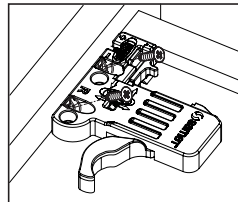
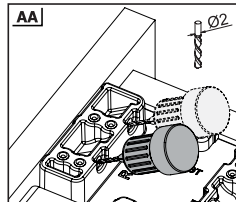

2

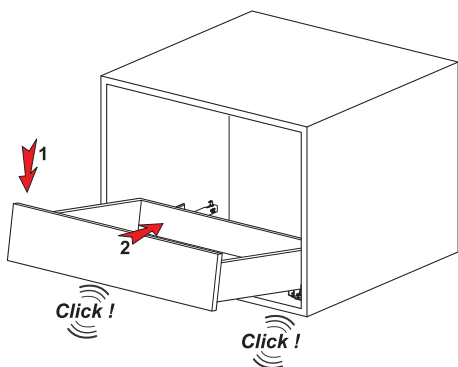

3

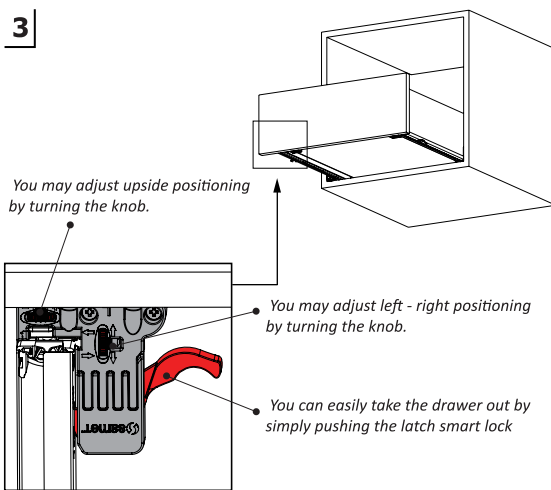

Smart Drilling Jig

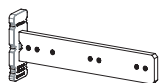

Kod / Code

12799902

12799904

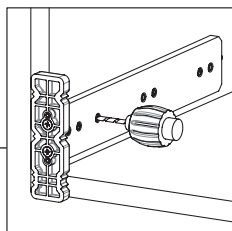
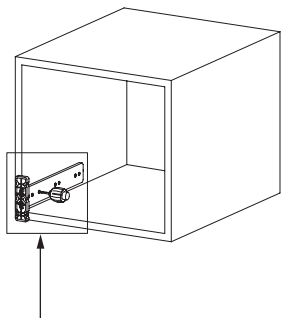

Smart Drilling Jig with Ruler

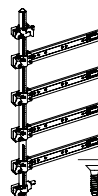

Kod / Code

12799901

12799905

