

Sliding Door Hardware

Bi-fold | By-Pass | Pocket



John Sterling

Sliding Door Hardware

The John Sterling™ Sliding Door Hardware products offer a complete line of hardware for interior sliding Bi-Fold doors, By-Pass doors, Pocket doors and Pocket doors with frame kits. Having been in the market for over 60 years, our Sliding Door Hardware program features a broad range of size and weight options.

The buyers, builders and do-it-yourself customers will find everything they need for Sliding Door Hardware, including the finest customer service team in the industry.

The John Sterling™ name means quality and innovation, with products that are designed and built to last a lifetime. We deliver superior products at an exceptional value.



Bi-Fold Sliding Door Hardware

A Bi-Fold door is a door unit that folds in pairs. Bi-Folds are most commonly used for closets, but may also be used as sliding doors between rooms.



By-Pass Sliding Door Hardware

A By-Pass door is a sliding door unit that has two or more sections. The doors can slide in either direction sliding past each other. By-Pass doors are most commonly used in closets, in order to access one side of the closet at a time. The doors in a By-Pass unit will overlap slightly when viewed from the front, in order not to have a visible gap between them.



Pocket Sliding Door Hardware

A Pocket door is a sliding door that disappears, when fully open, between two wall panels in the adjacent wall.





Bi-Fold Sliding Door Hardware

Bi-Fold doors are applicable in a broad range of environments from pantries, laundries and closets.



Package Features

Trilingual

Reach expanding/international markets

Instruction Sheets

All product has easy-to-follow instructions with graphics

Hardware Included

All pertinent hardware and fasteners are included

Easy to Merchandise

Planograms to fit your needs



2-Door Application



4-Door Application

20 lb. Kit R-BIF-20

Packaged set for 20 lb. panels

Lengths & Part Numbers

3' R-BIF-20-2D3	4' R-BIF-20-4D4
5' R-BIF-20-4D5	6' R-BIF-20-4D6
6' R-BIF-20-4D6	8' R-BIF-20-4D8

Door Thickness: 3/4" to 1-3/4"

Load Rating: Up to 20 lbs. per panel

Track: White steel track

Conforms to: ANSI/BHMA A156.14-2007 Grade 3, D8623

Package Contents:

	2-Door	4-Door
Track	Yes	Yes
Track Pivot Assembly	1	2
Bottom Jamb Bracket	1	2
Bottom Pivot	1	2
Top Pivot & Top Guide	2	4
Snubber	1	1
Hinge	2	4
Wood Knob	1	2
Aligner	0	2
Screws	Yes	Yes

NOTE: R-BIF-20-4D6 comes with two tracks. This is a display advantage as the package set is shorter than providing it with the 72" length track.



Bi-Fold Sliding Door Hardware



2-Door Application

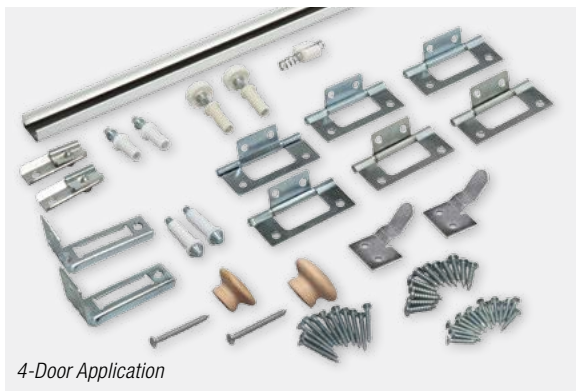

4-Door Application

30 lb. Kit R-BIF-30

Packaged set for 30 lb. panels

Lengths & Part Numbers

3' R-BIF-30-2D3	4' R-BIF-30-4D4
5' R-BIF-30-4D5	6' R-BIF-30-4D6
8' R-BIF-30-4D8	

Door Thickness: 3/4" to 1-3/4"

Load Rating: Up to 30 lbs. per panel

Track: White steel track

Conforms to: ANSI/BHMA A156.14-2007 Grade 2, D8622, D8623

Package Contents:

	2-Door	4-Door
Track	Yes	Yes
Bottom Jamb Bracket	1	2
Bottom Pivot	1	2
Top Pivot	1	2
Top Guide	1	2
Snubber	1	1
Hinge	3	6
Wood Knob	1	2
Aligner	0	2
Screws	Yes	Yes



2-Door Application



4-Door Application

50 lb. Kit R-BIF-50

Packaged set for 50 lb. panels

Lengths & Part Numbers

3' R-BIF-50-2D3	4' R-BIF-50-4D4
6' R-BIF-50-4D6	8' R-BIF-50-4D8

Door Thickness: 3/4" to 1-3/4"

Load Rating: Up to 50 lbs. per panel

Track: Steel box track

Carrier: 4-wheel low friction bearing

Conforms to: ANSI/BHMA A156.14-2007 Grade 1, D8621, D8622, D8623

Package Contents:

	2-Door	4-Door
Track	Yes	Yes
Door Guide Plate	1	2
Adjusting Screw Assembly	1	2
Jamb Bracket Assembly	1	2
Pivot Pin Plate	1	2
Heavy-Duty Track Pivot Assembly	1	2
Top Mount Plate	1	2
4-Wheel Carrier	1	2
Snugger	1	2
Hinge	3	6
Wood Knob	1	2
Aligner	0	2
Wrench	1	1
Screws	Yes	Yes

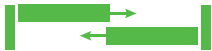

By-Pass Sliding Door Hardware

By-Pass doors are the traditional sliding door solution for any size closet, doors between rooms, storage walls and moveable partitions.



Package Features

Trilingual

Reach expanding/international markets

Instruction Sheets

All product has easy-to-follow instructions with graphics

Hardware Included

All pertinent hardware and fasteners are included

Easy to Merchandise

Planograms to fit your needs



2-Door Application

50 lb. Kit R-BYP-50

Packaged set for 50 lb. doors

Lengths & Part Numbers

4'	R-BYP-50-2D4	5'	R-BYP-50-2D5
6'	R-BYP-50-2D6	8'	R-BYP-50-2D8

Door Thickness: 3/4" to 1-3/8"

Load Rating: Up to 50 lbs. per panel

Track: Double J steel track

Carrier: Single wheel, low friction bearing

Conforms to: ANSI/BHMA A156.14-2007 Grade 2, D8742

Package Contents:

	2-Door
Track	Yes
Single Wheel Carrier A	2
Single Wheel Carrier B	2
Door Guide	1
Finger Pull	2
Door Stop	1
Screws	Yes



By-Pass Sliding Door Hardware



2-Door Application

50 lb. Kit R-BYP-50-C

Packaged set for 50 lb. doors

Lengths & Part Numbers

4' R-BYP-50-2D4-C	5' R-BYP-50-2D5-C
6' R-BYP-50-2D6-C	8' R-BYP-50-3D8-C

Door Thickness: 3/4" to 1-3/8"

Load Rating: Up to 50 lbs. per panel

Track: Double J steel track

Carrier: Single wheel, low friction bearing with CAM adjustment

Conforms to: ANSI/BHMA A156.14-2007 Grade 2, D8742

Package Contents:

	2-Door	3-Door
Track	Yes	Yes
Single Wheel Carrier A	2	2
Single Wheel Carrier B	2	4
Door Guide	1	2
Finger Pull	2	3
Door Stop	1	1
Screws	Yes	Yes



2-Door Application

60 lb. Kit R-BYP-60AFR

Packaged set for 60 lb. doors

Lengths & Part Numbers

4' R-BYP-60AFR-2D4	5' R-BYP-60AFR-2D5
6' R-BYP-60AFR-2D6	8' R-BYP-60AFR-2D8

Door Thickness: 1-3/8"

Load Rating: Up to 60 lbs. per panel

Track: Double J aluminum track with 1-3/4" ribbed fascia

Carrier: Single wheel, low friction bearing

Conforms to: ANSI/BHMA A156.14-2007 Grade 2, D8752

Package Contents:

	2-Door
Track	Yes
Single Wheel Carrier B	4
Floor Guide	1
Finger Pull	2
Door Stop	1
Screws	Yes



By-Pass Sliding Door Hardware

100 lb. Kit R-BYP-100

Packaged set for 100 lb. doors

Lengths & Part Numbers

4' R-BYP-100-2D4	5' R-BYP-100-2D5
6' R-BYP-100-2D6	8' R-BYP-100-2D8

Door Thickness: 1-3/8" to 1-3/4"

Load Rating: Up to 100 lbs. per panel

Track: Double aluminum box track

Carrier: 4-wheel

Conforms to: ANSI/BHMA A156.14-2007 Grade 1, D8741, D8742

Package Contents:

Track	2-Door
4-Wheel Carrier	Yes
Top Mount Plate	4
Door Guide	4
Finger Pull	1
Door Stop	2
Wrench	1
Screws	1
	Yes



2-Door Application



Pocket Sliding Door Hardware

Pocket doors are a great way to save space working well for master bathrooms, wardrobes, dining rooms or anywhere floor space is a premium.



Package Features

Trilingual

Reach expanding/international markets

Instruction Sheets

All product has easy-to-follow instructions with graphics

Hardware Included

All pertinent hardware and fasteners are included

Easy to Merchandise

Planograms to fit your needs

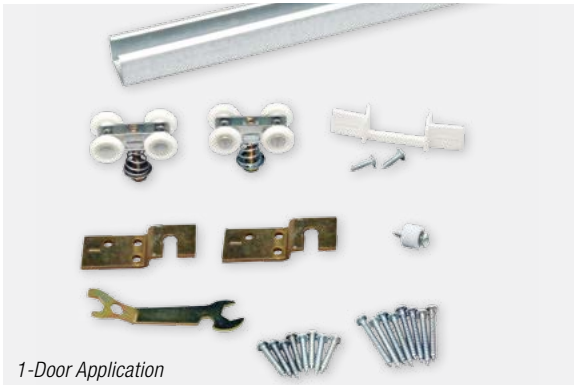

1-Door Application

75 lb. Kit R-PKT-75-6

Packaged set for 75 lb. door

Door Thickness: 1-1/8" - 1-3/4"

Load Rating: Up to 75 lbs. per door

Track: Steel box track

Carrier: 4-wheel, low friction bearing

Conforms to: ANSI/BHMA A156.14-2007 Grade 1, D8691, D8692 with bi-parting kit: Grade 1, D8721, D8722

Package Contents:

	1-Door
Track	Yes
4-Wheel Carrier	2
Top Mount Plate	2
Door Guide	1
Door Bumper	1
Wrench	1
Screws	Yes



Pocket Sliding Door Hardware



150 lb. Kit R-PKT-150-6

Packaged set for 150 lb. door

Door Thickness: 1-3/8" - 1-3/4"

Load Rating: Up to 150 lbs. per door

Track: Aluminum box track

Carrier: 4-wheel ball bearing

Conforms to: ANSI/BHMA A156.14-2007 Grade 1, D8681, D8691, D8692 with bi-parting kit: Grade 1, D8711, D8721, D8722

Package Contents:

	1-Door
Track	Yes
4-Wheel Carrier	2
Top Mount Plate	2
Door Guide	1
Door Bumper	1
Wrench	1
Screws	Yes

Pocket Frame Kits Sliding Door Hardware

Pocket frame kits make framing for pocket doors a snap. In addition to the pocket door track and carrier hardware, the kits include steel reinforced split studs, header and nailing board and doorway-end brackets, everything an installer needs.



Package Features

Trilingual

Reach expanding/international markets

Instruction Sheets

All product has easy-to-follow instructions with graphics

Hardware Included

All pertinent hardware and fasteners are included

Easy to Merchandise

Planograms to fit your needs



Pocket Sliding Door Hardware



1-Door Application

75 lb. Kit R-PKF-75

Frame kit for 75 lb. door

Door Thickness: 1-3/8" - 1-3/4"
 Door Height: 6' 8"
 Load Rating: Up to 75 lbs. per door
 Track: Steel box track
 Carrier: 4-wheel, low friction bearing
 Conforms to: ANSI/BHMA A156.14-2007 Grade 2, D8672
 with bi-parting kit: Grade 1, D8721, D8722

Package Contents:

	1-Door
Track Header Assembly	1
Split Stud	4
Floor Plate	2
4-Wheel Carrier	2
Top Mount Plate	2
Door Guide	1
Door Bumper	1
Track End Bracket	1
Wrench	1
Screws	Yes



1-Door Application

150 lb. Kit R-PKF-150

Frame kit for 150 lb. door

Door Thickness: 1-3/8" - 1-3/4"
 Door Height: 6' 8"
 Load Rating: Up to 150 lbs. per door
 Track: Aluminum box track
 Carrier: 4-wheel, ball bearing
 Conforms to: ANSI/BHMA A156.14-2007 Grade 1, D8671, D8672
 with bi-parting kit: Grade 1, D8711, D8721, D8722

Package Contents:

	1-Door
Track Header Assembly	1
Split Stud	4
Floor Plate	2
4-Wheel Carrier	2
Top Mount Plate	2
Door Guide	2
Door Bumper	1
Doorway End Bracket	1
Pocket End Bracket	1
Wrench	1
Screws	Yes

Replacement Parts & Accessories

BI-FOLD	Description	
R-PB-BIF-20-2	Parts for 2 panels	
R-PB-BIF-30-2	Parts for 2 panels	
R-PB-BIF-50-2	Parts for 2 panels	
CD-8220-US3	2 Non-mortise hinges with screws; Brass finish	
CD-8220-US15	2 Non-mortise hinges with screws; Satin Nickel finish	
CD-8220-US10	2 Non-mortise hinges with screws; Dark Bronze finish	
CD1064-US3	Folding door lock, keyed different; Brass finish	
CD1064-US3A	Folding door lock, keyed alike; Brass finish	
CD1064-US26D	Folding door lock, keyed different; Nickel finish	
CD1064-26DA	Folding door lock, keyed alike; Nickel finish	
CD1064-US10	Folding door lock, keyed different; Dark Bronze finish	
CD1064-US10A	Folding door lock, keyed alike; Dark Bronze finish	



CD-8220-US3



CD1064-26DA

BY-PASS	Description	
CD-0200-A	3/8" Hanger; One pair per card; 50 lbs.	
CD-0200-B	11/16" Hanger; One pair per card; 50 lbs.	
CD-0353	Adjustable door guide for 3/4" - 1-3/8"	
CD-0340	Jump proof guard; 4 per card	
CD-0880	Door stops	
CD-0400-A	3/8" Hanger; One pair per card; 50 lbs.; Micro Cam Adj.	
CD-0400-B	11/16" Hanger; One pair per card; 50 lbs.; Micro Cam Adj.	
CD-7200-B	11/16" Hanger; One pair per card; 60 lbs.	
R-PB-BYP-100-2	Parts for 2 doors	
CD-0354	3/4" riser used with door guides 0351 or 0353	
CD-0909	Heavy-duty adjustable door guide; 3/4" - 1-3/4"	
CD-0351	Non-adjustable door guide; Beige	
CD-0351-WT	Non-adjustable door guide; White	
CD1068-US3	Sliding door lock, keyed different; Brass finish	
CD1068-US3A	Sliding door lock, keyed alike; Brass finish	
CD1068-US26D	Sliding door lock, keyed different; Nickel finish	
CD1068-26DA	Sliding door lock, keyed alike; Nickel finish	
CD1068-US10	Sliding door lock, keyed different; Dark Bronze finish	
CD1068-US10A	Sliding door lock, keyed alike; Dark Bronze finish	
CD-0864-US3	3/4" finger pull; Brass finish	
CD-0864-US15	3/4" finger pull; Satin Nickel finish	
CD-0864-US10	3/4" finger pull; Dark Bronze finish	
CD-0868-US3	2-1/8" finger pull; Brass finish	
CD-0868-US15	2-1/8" finger pull; Satin Nickel finish	
CD-0868-US10	2-1/8" finger pull; Dark Bronze finish	



CD-0909



CD1068-US10



CD-0353

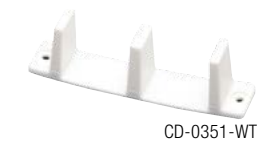

CD-0351-WT



CD-0200-A

CD-0200-B



CD-0880

CD-0864-US15

POCKET	Description	
R-PB-PKTF-75	Parts for 1 door	
R-PB-PKTF-150	Parts for 1 door	
R-BI-PKF-75	Bi-parting door adapter kit for R-PKF-75	
R-BI-PKF-150	Bi-parting door adapter kit for R-PKF-150	
CD-1038-US3	Passage pull; Brass finish	
CD-1038-US15	Passage pull; Satin Nickel finish	
CD-1038-US10	Passage pull; Dark Bronze finish	
CD-1039-US3	Passage privacy lock pull; Brass finish	
CD-1039-US15	Passage privacy lock pull; Satin Nickel finish	
CD-1039-US10	Passage privacy lock pull; Dark Bronze finish	
CD-0884-US3	Edge pull; Brass finish	
CD-0884-US15	Edge pull; Satin Nickel finish	
CD-0884-US10	Edge pull; Dark Bronze finish	
CD-0881	Pocket door bumper	
CD-0883	Pocket door guides; Beige	
CD-0883-WT	Pocket door guides; White	
CD-0889	Pocket door guide; White	

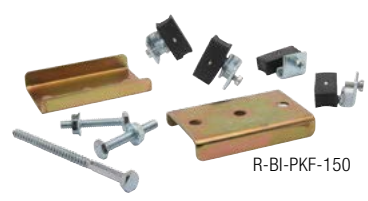

R-BI-PKF-150



CD-0884-US15

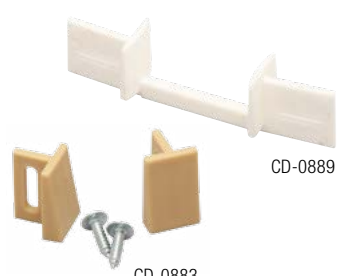

CD-0889

CD-0883



CD-1038-US3

Part Number	Description	Door Wt.	Door Thickness	Unit Dimensions			Unit Pack Qty.	Unit Wt. (lbs.)	Master Carton Cu. In.	Master Pack Qty.	Master Carton Wt. (lbs.)	UPC Code	SCM Code
BI-FOLD													
R-BIF-20-2D3	36" BiFold Pkg. Set for 20lb Panels (24":2 x 12" or 36": 2x18" Doors)	20 lbs.	3/4"-1-3/4"	36.0	2	1.4	1	2.00	504	5	10.0	077355015324	10077355015321
R-BIF-202T-4D6	48"-72" BiFold Pkg. Set for 20lb Panels (2 x 24" up to 48" Doors)	20 lbs.	3/4"-1-3/4"	36.0	2	1.4	1	2.27	504	5	11.4	077355015348	10077355015345
R-BIF-20-4D4	48" BiFold Pkg. Set for 20lb Panels (4 x 12" doors)	20 lbs.	3/4"-1-3/4"	47.8	2	1.4	1	2.20	669	5	11.0	077355534481	10077355534488
R-BIF-20-4D5	60" BiFold Pkg. Set for 20lb Panels (4 x 15" doors)	20 lbs.	3/4"-1-3/4"	59.8	2	1.4	1	2.30	837	5	11.5	077355534603	10077355534600
R-BIF-20-4D6	72" BiFold Pkg. Set for 20lb Panels (4 x 18" doors)	20 lbs.	3/4"-1-3/4"	71.8	2	1.4	1	2.50	1005	5	12.5	077355534726	10077355534723
R-BIF-20-4D8	96" BiFold Pkg. Set for 20lb Panels (4 x 24" doors)	20 lbs.	3/4"-1-3/4"	47.8	2	1.4	1	3.00	669	5	15.0	077355534962	10077355534969
R-BIF-30-2D3	36" BiFold Pkg. Set for 30lb Panels (2 x 18" doors)	30 lbs.	3/4" -1-3/4"	35.8	2	1.4	1	2.00	501	5	10.0	077355315424	10077355315421
R-BIF-30-4D4	48" BiFold Pkg. Set for 30lb Panels (4 x 12" doors)	30 lbs.	3/4"-1-3/4"	47.8	2	1.4	1	3.20	669	5	16.0	077355415445	10077355415442
R-BIF-30-4D5	60" BiFold Pkg. Set for 30lb Panels (4 x 15" doors)	30 lbs.	3/4"-1-3/4"	59.8	2	1.4	1	3.40	837	5	17.0	077355515442	10077355515449
R-BIF-30-4D6	72" BiFold Pkg. Set for 30lb Panels (4 x 18" doors)	30 lbs.	3/4"-1-3/4"	71.8	2	1.4	1	3.60	1005	5	18.0	077355615449	10077355615446
R-BIF-30-4D8	96" BiFold Pkg. Set for 30lb Panels (4 x 24" doors)	30 lbs.	3/4"-1-3/4"	47.8	2	1.4	1	4.52	669	5	22.6	077355815443	10077355815440
R-BIF-50-2D3	36" BiFold Pkg. Set for 50lb Panels (2 x 18" doors)	50 lbs.	3/4"-1-3/4"	37.3	3.8	2.2	1	3.00	1868	6	18.0	077355573619	10077355573616
R-BIF-50-4D4	48" BiFold Pkg. Set for 50lb Panels (4 x 12" doors)	50 lbs.	3/4"-1-3/4"	49.3	3.9	2.3	1	4.52	2651	6	27.1	077355574814	10077355574811
R-BIF-50-4D6	72" BiFold Pkg. Set for 50lb Panels (4 x 18" doors)	50 lbs.	3/4"-1-3/4"	73.3	3.10	2.4	1	5.41	3270	6	32.5	077355577211	10077355577218
R-BIF-50-4D8	96" BiFold Pkg. Set for 50lb Panels (4 x 24" doors)	50 lbs.	3/4"-1-3/4"	96.3	3.11	2.5	1	6.40	4490	6	38.4	077355579611	10077355579618
R-PB-BIF-20-2	Parts Bag for 20lb BiFold Series (2 doors)	20 lbs.	3/4"-1-3/4"	5.3	3.75	1.25	1	0.23	492	20	4.6	029274362478	10029274362475
R-PB-BIF-30-2	Parts Bag for 30lb BiFold Series (2 doors)	30 lbs.	3/4"-1-3/4"	5.3	3.75	1.25	1	0.28	492	20	5.6	029274362485	10029274362482
R-PB-BIF-50-2	Parts Bag for 50lb BiFold Series (2 doors)	50 lbs.	3/4"-1-3/4"	8.0	6	1.25	1	1.34	600	10	13.4	029274362812	10029274362819
CD-8220-US15	2 non-mortise hinges with screws. Satin Nickel		3/4"-1-3/4"	5.5	2.75	.75	1	.21	227	20	4.2	029274362492	10029274362499
CD-8220-US3	2 non-mortise hinges with screws. Brass		3/4"-1-3/4"	5.5	2.75	.75	1	.21	227	20	4.2	029274362508	10029274362505
CD-8220-US10	2 non-mortise hinges with screws. Dark Bronze		3/4"-1-3/4"	5.5	2.75	.75	1	.21	227	20	4.2	029274362515	10029274362512
CD1064-US3	Folding door lock, brass, keyed different		3/4"-1-3/8"	6.0	3.75	1.13	1	.38	127	5	1.9	077355106411	20077355106415
CD1064-US3A	Folding door lock, brass, keyed alike		3/4"-1-3/8"	6.0	3.75	1.13	1	.38	127	5	1.9	077355106428	20077355106422
CD1064-26DA	Folding door lock, nickel, keyed alike		3/4"-1-3/8"	6.0	3.75	1.13	1	.38	127	5	1.9	029274344665	20029274344669
CD1064-US26D	Folding door lock, nickel, keyed different		3/4"-1-3/8"	6.0	3.75	1.13	1	.38	127	5	1.9	029274344672	20029274344676
CD1064-US10	Folding door lock, dark bronze, keyed different		3/4"-1-3/8"	6.0	3.75	1.13	1	.38	127	5	1.9	029274362522	10029274362529
CD1064-US10A	Folding door lock, dark bronze, keyed alike		3/4"-1-3/8"	6.0	3.75	1.13	1	.38	127	5	1.9	029274362539	10029274362536
BY-PASS													
R-BYP-50-2D4	48" ByPass Pkg. Set 50lb Series (2 x 24" doors)	50 lbs.	3/4"-1-3/8"	46.9	1.95	1.1	1	2.27	1005	10	22.7	077355206470	10077355206477
R-BYP-50-2D5	60" ByPass Pkg. Set 50lb Series (2 x 30" doors)	50 lbs.	3/4"-1-3/8"	58.9	1.95	1.1	1	2.67	1263	10	26.7	077355206593	10077355206590
R-BYP-50-2D6	72" ByPass Pkg. Set 50lb Series (2 x 36" doors)	50 lbs.	3/4"-1-3/8"	70.9	1.95	1.1	1	3.07	1520	10	30.7	077355206715	10077355206712
R-BYP-50-2D8	96" ByPass Pkg. Set 50lb Series (2 x 48" doors)	50 lbs.	3/4"-1-3/8"	93.9	1.95	1.1	1	3.98	2014	10	39.8	077355206944	10077355206941
R-BYP-50-2D4-C	48" ByPass Pkg. Set 50lb Series w/ CAM adjustment (2 x 24" doors)	50 lbs.	3/4"-1-3/8"	46.9	1.95	1.1	1	2.40	1005	10	24.0	077355409475	10077355409472
R-BYP-50-2D5-C	60" ByPass Pkg. Set 50lb Series w/ CAM adjustment (2 x 30" doors)	50 lbs.	3/4"-1-3/8"	58.9	1.95	1.1	1	2.90	1263	10	29.0	077355409598	10077355409595
R-BYP-50-2D6-C	72" ByPass Pkg. Set 50lb Series w/ CAM adjustment (2 x 36" doors)	50 lbs.	3/4"-1-3/8"	70.9	1.95	1.1	1	3.38	1520	10	33.8	077355409710	10077355409717

Part Number	Description	Door Wt.	Door Thickness	Unit Dimensions			Unit Pack Qty.	Unit Wt. (lbs.)	Master Carton Cu. In.	Master Pack Qty.	Master Carton Wt. (lbs.)	UPC Code	SCM Code
BY-PASS Cont'd.													
R-BYP-50-3D8-C	96" ByPass Pkg. Set 50lb Series w/ CAM adjustment (2 x 48" doors)	50 lbs.	3/4"-1-3/8"	93.9	1.95	1.1	1	5.20	2014	10	52.0	077355409949	10077355409946
R-BYP-60AFR-2D4	48" ByPass Pkg. Set 60lb w/ Ribbed Fascia (2 x 24" doors)	60 lbs.	1-3/8"	46.9	3.2	1.9	1	2.92	1425	5	14.6	029274362843	10029274362840
R-BYP-60AFR-2D5	60" ByPass Pkg. Set 60lb w/ Ribbed Fascia (2 x 30" doors)	60 lbs.	1-3/8"	58.9	3.2	1.9	1	3.72	1790	5	18.6	029274362850	10029274362857
R-BYP-60AFR-2D6	72" ByPass Pkg. Set 60lb w/ Ribbed Fascia (2 x 36" doors)	60 lbs.	1-3/8"	70.9	3.2	1.9	1	4.46	2155	5	22.3	029274362867	10029274362864
R-BYP-60AFR-2D8	96" ByPass Pkg. Set 60lb w/ Ribbed Fascia (3 x 32" doors)	60 lbs.	1-3/8"	94.9	3.2	1.9	1	5.70	2884	5	28.5	029274362874	10029274362871
R-BYP-100-2D4	48" ByPass Pkg. Set 100lb Series (2 x 24" doors)	100 lbs.	1-3/8"-1-3/4"	46.9	3.2	1.15	1	3.61	863	5	18.1	077355001112	10077355001119
R-BYP-100-2D5	60" ByPass Pkg. Set 100lb Series (2 x 30" doors)	100 lbs.	1-3/8"-1-3/4"	58.9	3.2	1.15	1	4.12	1083	5	20.6	077355001129	10077355001126
R-BYP-100-2D6	72" ByPass Pkg. Set 100lb Series (2 x 36" doors)	100 lbs.	1-3/8"-1-3/4"	70.9	3.2	1.15	1	4.63	1304	5	23.2	077355001136	10077355001133
R-BYP-100-2D8	96" ByPass Pkg. Set 100lb Series (2 x 48" doors)	100 lbs.	1-3/8"-1-3/4"	94.9	3.2	1.15	1	5.61	1746	5	28.1	029274362898	10029274362895
CD-0200-A	3/8" Hanger, One Pair Per Card 50 lbs	50 lbs.	3/4"-1-3/8"	5.9	3.75	1.3	1	0.17	286	10	1.7	077355120011	10077355120018
CD-0200-B	11/16" Hanger, One Pair Per Card 50 lbs	50 lbs.	3/4"-1-3/8"	5.9	3.75	1.3	1	0.17	286	10	1.7	077355120028	10077355120025
CD-0400-A	3/8" Hanger, One Pair Per Card 50 lbs Micro Cam	50 lbs.	3/4"-1-3/8"	5.9	3.75	1.3	1	0.26	286	10	2.6	029274362829	10029274362826
CD-0400-B	11/16" Hanger, One Pair Per Card 50 lbs Micro Cam	50 lbs.	3/4"-1-3/8"	5.9	3.75	1.3	1	0.26	286	10	2.6	029274362836	10029274362833
CD-7200-B	Single wheel carrier, offset B, 7/8" diameter wheel	60 lbs.	1-3/8"	5.9	3.75	1.3	1	0.20	286	10	2.0	029274362881	10029274362888
R-PB-BYP-100-2	Parts Bag for 100lb ByPass Series (2 doors)	100 lbs.	1-3/8" 1-3/4"	8.0	6	1.75	1	1.54	840	10	15.4	029274362904	10029274362901
CD-0340	Jump Proof Guard, 4 Per Card			5.9	3.75	1.3	1	0.17	172	6	1.0	077355003406	10077355003403
CD-0353	Adjustable Door Guide for 3/4" to 1-3/8"		3/4"-1-3/8"	6.0	3.75	1.13	1	0.08	254	10	0.8	077355103533	10077355103530
CD-0909	Heavy Duty Adjustable Door Guide 3/4" - 1-3/4"		3/4"-1-3/4"	7.3	3.5	1.25	1	0.21	317	10	2.1	077355090918	10077355090915
CD-0351	Non-adjustable door guide - beige		3/4"-1-3/4"	6.8	3.25	1	1	0.10	219	10	1.0	029274362546	10029274362543
CD-0351-WT	Non-adjustable door guide - white		3/4"-1-3/4"	6.8	3.25	1	1	0.10	219	10	1.0	029274362577	10029274362574
CD-0354	3/4" Riser used with door guides 0351 or 0353			6.5	3.75	1.8	1	0.10	439	10	1.0	077355103540	10077355103547
CD-0880	Door Stops			5.0	3	.75	1	0.06	113	10	0.6	077355208801	10077355208808
CD1068-US3	Sliding door lock, brass, keyed different		3/4"-1-3/4"	6.0	3.75	1.13	1	0.31	127	5	1.6	077355010688	20077355010682
CD1068-US3A	Sliding door lock, brass, keyed alike		3/4"-1-3/4"	6.0	3.75	1.13	1	0.31	127	5	1.6	077355210682	20077355210686
CD1068-US26D	Sliding door lock, nickel, keyed different		3/4"-1-3/4"	6.0	3.75	1.13	1	0.31	127	5	1.6	077355410686	20077355410680
CD1068-26DA	Sliding door lock, nickel, keyed alike		3/4"-1-3/4"	6.0	3.75	1.13	1	0.31	127	5	1.6	077355510683	20077355510687
CD1068-US10	Sliding door lock, dark bronze, keyed different		3/4"-1-3/4"	6.0	3.75	1.13	1	0.31	127	5	1.6	029274362584	10029274362581
CD1068-US10A	Sliding door lock, dark bronze, keyed alike		3/4"-1-3/4"	6.0	3.75	1.13	1	0.31	127	5	1.6	029274362591	10029274362598
CD-0864-US3	4 Finger pulls 3/4" brass			5.5	3.75	0.75	1	0.04	309	20	0.8	029274362614	10029274362611
CD-0864-US15	4 Finger pulls 3/4" satin nickel			5.5	3.75	0.75	1	0.04	309	20	0.8	029274362621	10029274362628
CD-0864-US10	4 Finger pulls, 3/4" dark bronze			5.5	3.75	0.75	1	0.04	309	20	0.8	029274362638	10029274362635
CD-0868-US3	2 Finger pulls 2-1/8" brass			5.5	3.75	1	1	0.07	413	20	1.4	029274362645	10029274362642
CD-0868-US15	2 Finger pulls 2-1/8" satin nickel			5.5	3.75	1	1	0.07	413	20	1.4	029274362652	10029274362659
CD-0868-US10	2 Finger pulls 2-1/8" dark bronze			5.5	3.75	1	1	0.07	413	20	1.4	029274362669	10029274362666

Part Number	Description	Door Wt.	Door Thickness	Unit Dimensions			Unit Pack Qty.	Unit Wt. (lbs.)	Master Carton Cu. In.	Master Pack Qty.	Master Carton Wt. (lbs.)	UPC Code	SCM Code
POCKET / POCKET FRAME KITS													
R-PKT-75-6	72" Pkg. Set for 75lb Pocket Door (One 36" Door)	75 lbs.	1-1/8"-1-3/4"	72.0	2	1.75	1	3.20	1260	5	16.0	029274362928	10029274362925
R-PB-PKTF-75	Parts Bag - one 75lb Door	75 lbs.		7.5	5	1.5	1	0.53	2250	40	21.2	029274362942	10029274362949
R-BI-PKF-75	Bi-Parting Door Adapter Kit for R-PKF-75	75 lbs.		5.5	3.75	1	1	0.19	206	10	1.9	029274362676	10029274362673
R-PKT-150-6	72" Pkg. Set for 150lb Pocket Door (One 36" Door)	150 lbs.	1-3/8"-1-3/4"	72.0	2	1.75	1	3.10	1260	5	15.5	029274370589	10029274370586
R-PB-PKTF-150	Parts Bag - one 150lb Door	150 lbs.		8.0	6	1.25	1	0.70	600	10	7.0	029274362980	10029274362987
R-BI-PKF-150	Bi-Parting Door Adapter Kit for R-PKF-150	150 lbs.		5.9	3.75	1.5	1	0.57	330	10	5.7	077355163902	10077355163909
R-PKF-75	6'8" Tall Pkg. 75lb Pocket Frame Kit (One 36" Door)	75 lbs.	1-3/8"-1-3/4"	86.0	4.5	3.75	1	27.90	1451	1	27.9	077355143010	10077355143010
R-PKF-150	6'8" Tall Pkg. 150lb Pocket Frame Kit (One 36" Door)	150 lbs.	1-3/8"-1-3/4"	86.0	4.5	3.75	1	29.00	1451	1	29.0	029274362973	10029274362970
CD-1038-US3	Passage Pull Brass		1-3/8"-1-3/4"	6.0	3.75	1.38	1	0.28	186	6	1.7	077355103816	10077355103813
CD-1038-US15	Passage Pull Satin Nickel		1-3/8"-1-3/4"	6.0	3.75	1.38	1	0.28	186	6	1.7	077355103830	10077355103837
CD-1038-US10	Passage Pull Dark Bronze		1-3/8"-1-3/4"	6.0	3.75	1.38	1	0.28	186	6	1.7	029274362683	10029274362680
CD-1039-US3	Passage Privacy Lock Pull Brass		1-3/8"-1-3/4"	6.0	3.75	1.38	1	0.36	186	6	2.2	077355310399	10077355310396
CD-1039-US15	Passage Privacy Lock Pull Satin Nickel		1-3/8"-1-3/4"	6.0	3.75	1.38	1	0.36	186	6	2.2	077355103960	10077355103967
CD-1039-US10	Passage Privacy Lock Pull Dark Bronze		1-3/8"-1-3/4"	6.0	3.75	1.38	1	0.36	186	6	2.2	029274362690	10029274362697
CD-0884-US3	Edge Pull Brass			6.0	3.75	.5	1	0.09	113	10	0.9	077355208849	10077355208846
CD-0884-US15	Edge Pull Satin Nickel			6.0	3.75	.5	1	0.09	113	10	0.9	077355088410	10077355088417
CD-0884-US10	Edge Pull Dark Bronze			6.0	3.75	.5	1	0.09	113	10	0.9	029274362706	10029274362703
CD-0881	Pocket door bumper			5.5	3.75	.5	1	0.03	103	10	0.3	029274362775	10029274362772
CD-0883	Pocket door guide, Beige			5.5	3.75	.5	1	0.03	103	10	0.3	029274362782	10029274362789
CD-0883-WT	Pocket door guide, white			5.5	3.75	.5	1	0.03	103	10	0.3	029274362799	10029274362796
CD-0889	Pocket door guide, white			5.5	3.75	.88	1	0.04	182	10	0.4	029274362805	10029274362802

Sliding Door Hardware Blister Cards



R-PB-BIF-30-2



CD1064-US3A



CD8220-US10



CD-0868-US3



CD-0864-US10



CD-0909



CD-0351-WT



CD-0883



CD-0881



CD-0889



CD-0884-US15

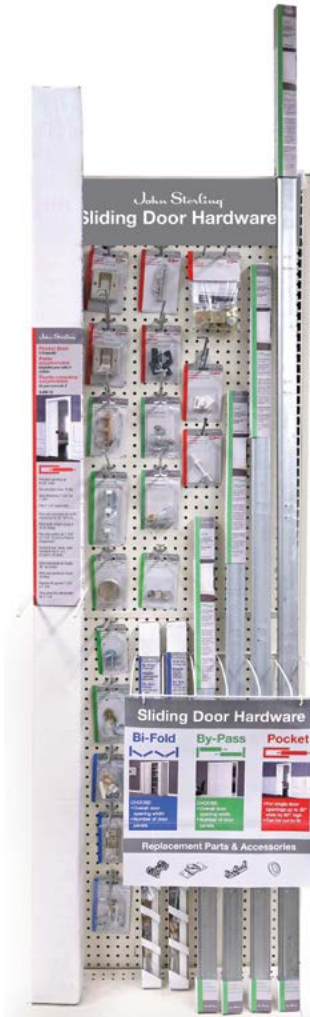

2 ft. Planogram



3 ft. Planogram

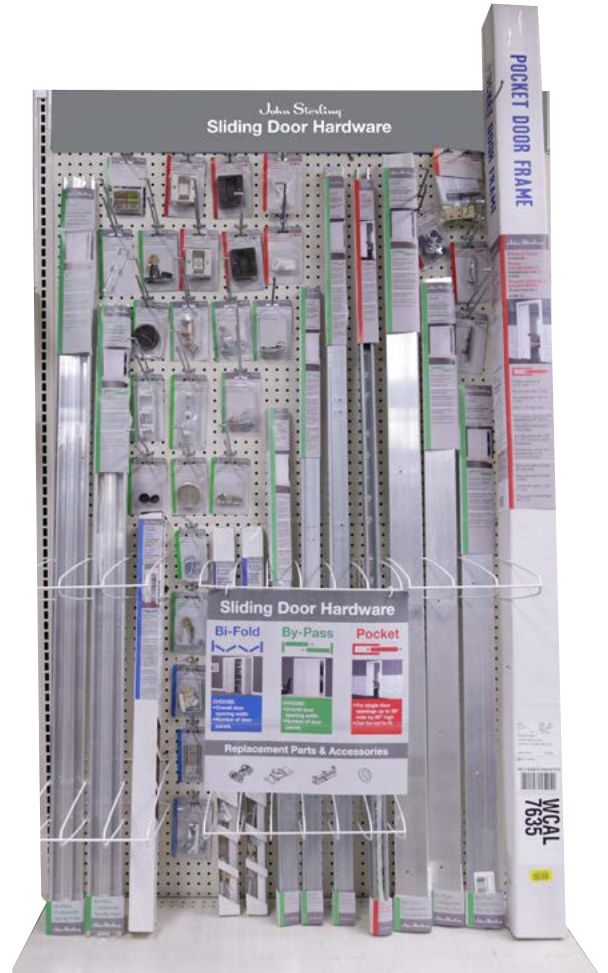

4 ft. Planogram



KNAPE & VOGT